



# Tropic

**USER MANUAL**



# TROPIC

## USER MANUAL

**Copyright © 2023 AJAX DETECTION TECHNOLOGY LTD. All rights reserved.**

No part of this manual, including the products and software described in it, may be reproduced, transmitted, transcribed, stored in a retrieval system, or translated into any language in any form or by any means, except documentation kept by the purchaser for backup purposes, without the express written permission of AJAX DETECTION TECHNOLOGY LTD. («AJAX»).

Product warranty or service will not be extended if: (1) the product is repaired, modified or altered, unless such repair, modification or alteration is authorized in writing by AJAX: or (2) the serial number of the product is defaced or missing.

Ajax provides this manual «as is» without warranty of any kind, either Express or implied, including but not limited to the implied warranties for Conditions of merchantability or fitness for a particular purpose. In no Event shall ajax, its directors, officers, employees or agents be liable for any Indirect, special, incidental, or consequential damages (including damages For loss of profits, loss of business, loss of use or data, interruption of Business and the like), even if ajax has been advised of the possibility of such Damages arising from any defect or error in this manual or product.

Specifications and information contained in this manual are furnished For informational use only, and are subject to change at any time without Notice, and should not be construed as a commitment by ajax. Ajax assumes No responsibility or liability for any errors or inaccuracies that may appear In this manual, including the products and software described in it.

Products and corporate names appearing in this manual may or may not be registered trademarks or copyrights of their respective companies, and are used only for identification explanation and to the owners benefit, without intent to infringe.

Index	4
Safety information	5
Introduction	6
A thanking message	7
Technical Specifications	8
Package Components	9
Battery Specifications	10
Warnings	11
General View	12
Keys & Buttons	13
Initial Set Up	15
Main User Interface	16
Settings	17
Tropic Device Specifications	21
Pre Use Tips	22
EFM Electromagnetic System	23
Device Set Up For EFM System	24
Calibration	26
Sensitivity	27
Iron discard	27
Tones	28
Quick Scan	29
Scan Method (Quick scan)	30
Discrimination	32
Scan Method (Discrimination)	33
Graph	34
Scan Method (Graph)	35
Notes	36
Contact Info	39



# TROPIC Safety information



The components included in this package are prone to damage from electrostatic discharge [ESD]. Please adhere to the following instructions to ensure successful device assembly.

Ensure that all components are securely connected. Loose connections may cause the device to not recognize a component or fail to start.

Hold the device firmly when assembling or operating.

It is recommended to discharge yourself of static electricity by touching another metal object before handling the device.

Store the device in an electrostatic free environment whenever the device is not in use.



Do not assemble or operate the device before reading the user manual. This might cause permanent damage to the components as well as injury to the user.



If you need help during installation step, please consult support via phone or Online help-desk.



Always turn off the device before storing the device.



Keep this user manual for future reference.



Keep this device away from humidity.

Make sure that your electrical outlet provides the same voltage as is indicated on the Charger before connecting to the electrical outlet.

All cautions and warning on the device and in the user manual should be noted.

If any of the following situations arises, get the device

checked by service personnel:

Liquid has penetrated into the device.

The device has been exposed to moisture.

The device does not work well or you can not get it work according to user manual.

 The device has been dropped or damaged.

 The device has obvious sign of breakage.

Do not leave the device in an environment above °60C (°140F), it may damage the device.

## Where to find more information

Refer to the following sources for additional information and for product and software updates.

### 1. AJAX websites:

The AJAX website provides updated information on AJAX hardware and software products. Refer to the AJAX contact information.

### 2. Optional documentation:

Your product package may include optional documentation, such as warranty fliers, that may have been added by your dealer. These documents are not part of the standard package.

As Ajax has always promised to provide the latest devices with new systems in the field of detecting treasures and precious metals, today we present to you the new Tropic device equipped with the latest systems that have been accomplished in Ajax laboratories with the expertise of its engineering and technical team to detect targets that were previously out of reach.

Tropic is characterized by the electromagnetic EFM system developed by AJAX, it is completely new and contains several diverse systems that outperform all previous detection systems in terms of accuracy, depth, and target type identification.

A decorative horizontal separator consisting of a central black diamond shape, flanked by two horizontal lines that taper to points, with small black diamonds along the lines.

Thanks for purchasing AJAX product

A decorative horizontal separator consisting of a central black diamond shape, flanked by two horizontal lines that taper to points, with small black diamonds along the lines.

User manual has full explanation about the product.

## Technical specifications

**Operating principle:** Analyzing signals, processing data, and converting them into visual and audio results.

**Processor:** ARM 3- Cortex

**Screen:** Color TFT, 5 inch, 800x480 WVGA resolution, 24 bits color depth.

**Power Source:** External power “Battery”.

**Battery Charger:** 15V – 1.2 A .

**Battery working hours:** more than 10 hours continuous with maximum brightness level and maximum sound level.

**Sound:** The device is equipped with a high-quality audio output.

**Vibration:** Optional, (the closer the target is, the more intense the vibration and the intensity of the sound).

**Languages:** The device supports six languages.

**Time & Date:** Yes

**Full weight with battery:** 2.35 KG

**Package weight:** 5 KG

**Bag dimensions:** 65 X 50 X 18 cm

**Operating temperature:** 10°C - 60°C

**Storage temperature:** 10°C- 80°C

**Humidity level:** Can be used and stored in a 100% humidity level.

**Search coil dimensions:** 35 X 35 cm

**After setting up device dimensions:** 24 X 35 X 130 cm while stick on maximum length, 24 X 35 X 113 cm while the stick on minimum length

# Package components

- 1 Main unit
- 2 Connection unit
- 3 Search coil
- 4 Clamp Nut / 2 pieces
- 5 Device Clamp
- 6 Clamp Bolt / 2 pieces
- 7 Carrying Pole
- 8 Extension Pole
- 9 Search Coil Bolt and Nut
- 10 Headphones
- 11 Charger
- 12 Battery

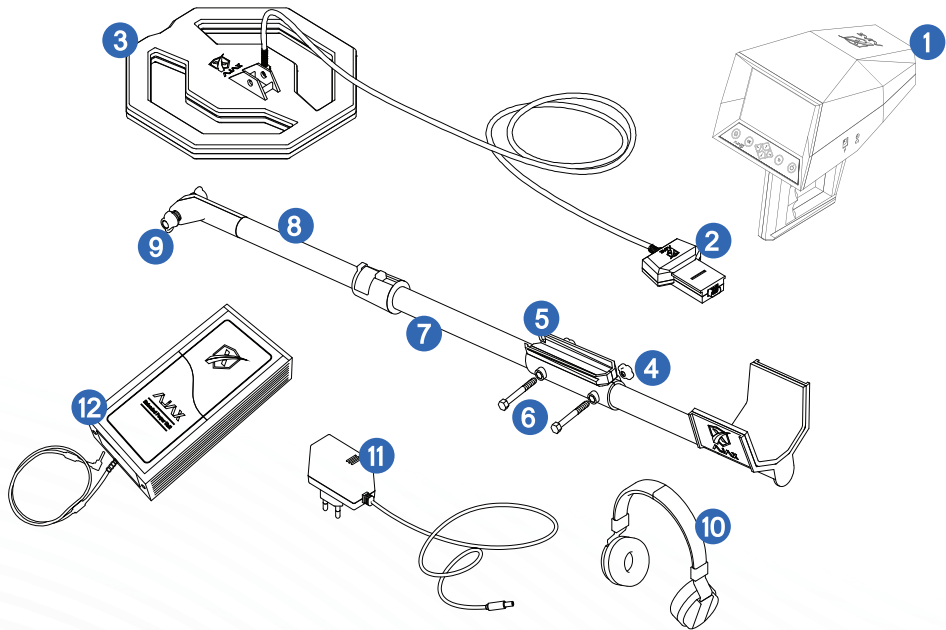

## Battery specifications

- Type: Lithium – Ion
- Capacity: 30000 mA
- Battery Charger: 15V – 1.2 A .
- Four LED pointers for battery level.
- Sound alarm when fully charged.
- Sound alarm with the ability to turn on/off.
- Sound alarm when battery level reaches less than 10%.
- 12V output with AJAX special cable.
- You can watch battery temperature to protect from high temperature while charging.
- Voltage: 12.6V
- You can watch battery charging current.
- Output current watching.
- On/Off button
- Auto turn off when not using the device.

### Battery Turn On:

You can turn it on by pressing the turn on button for 1 second until hearing the beep sound or viewing the LED pointer beside the turn on button.

### Battery Turn off:

You can turn off the battery by long press for 2 seconds (In case the charger is not connected).

### Battery Silent Mode:

When the battery is charging long press the turn on button for 10 seconds to be in the silent mode and viewing the LED pointer beside the turn on button.

### Battery Sound Mode:

When the battery is charging long press the turn on button for 10 seconds to be in the sound mode and view the LED pointer beside the turn on button.

**Warning: Be careful not to expose the battery to any heat source.**

- Items included with the device and accessories available may be subject to change by AJAX only.
- The included items are designed for compatibility with this device only and may not be compatible with other devices.
- Appearance and specifications are subject to change without prior notice.
- It is possible to purchase additional accessories or spare parts from AJAX distributors, check compatibility with the device before purchasing.
- Use only AJAX accessories or AJAX approved accessories.
- Use of unauthorized accessories may damage the device and performance and the device may be void of warranty due to misuse.
- All accessories are subject to change according to the manufacturer, the Ajax website provides you with information about accessories and their availability.

## General view

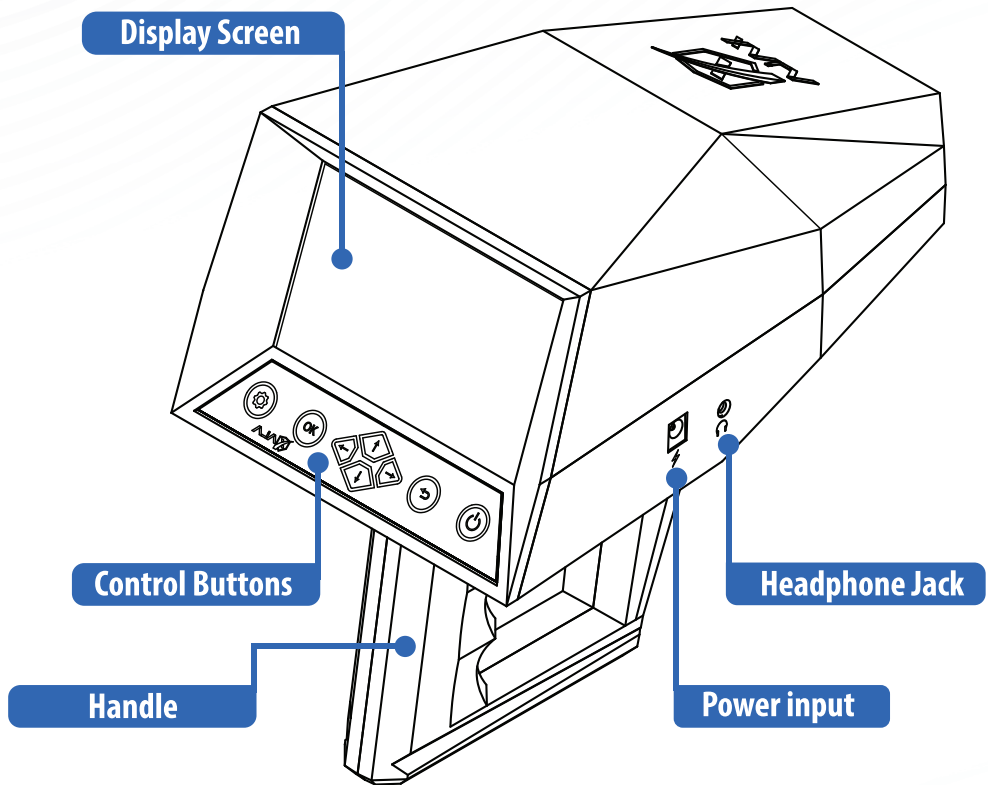

## Main Unit



# TROPIC Keys & Buttons

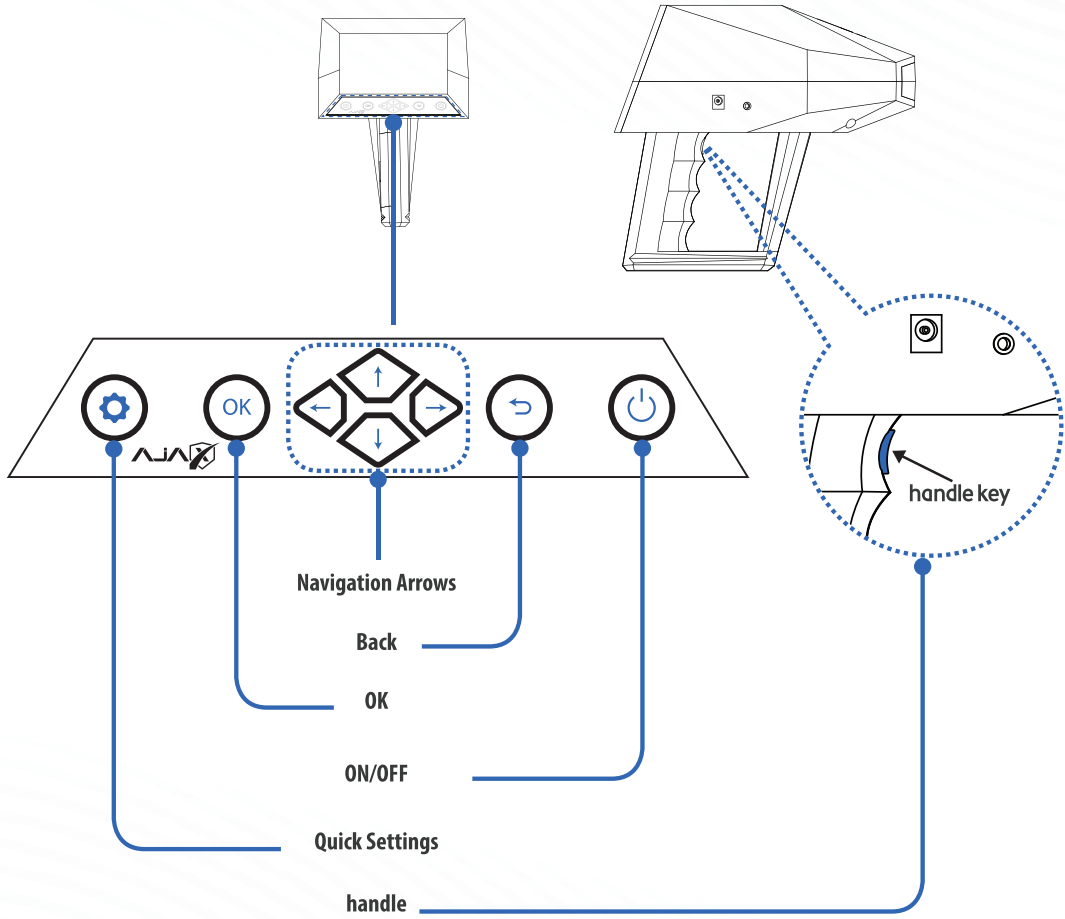

Key	Function
<b>ON/OFF</b>	5 Seconds long press to turn on or off
<b>OK</b>	Confirm and select
<b>Back</b>	To go back to previous menu or cancel the operation
<b>Navigation Arrows</b>	To move in the device's user interface and control search options.
<b>Quick Settings</b>	Press to show the quick settings menu
<b>Grip Key</b>	Multi-functional key to make search process easier

When booting the device for the first time or after factory reset, please follow the instructions on the display screen for system initial set up through setting time and date.

# TROPIC Initial set up

When booting the device for the first time or after the factory reset you should set time and date.

1- Turn on the device: Long press the power button for 5 seconds.

2- Choose the desired language then press OK.

3- Set time and date:

Clock Format: hh:mm:ss 24H format

Date Format: YY/MM/DD

And press OK.

After settings the main menu will appear on the screen.



# TROPIC Main user Interface

Contains three main icons:

- 1- EFM Systems
- 2- Settings

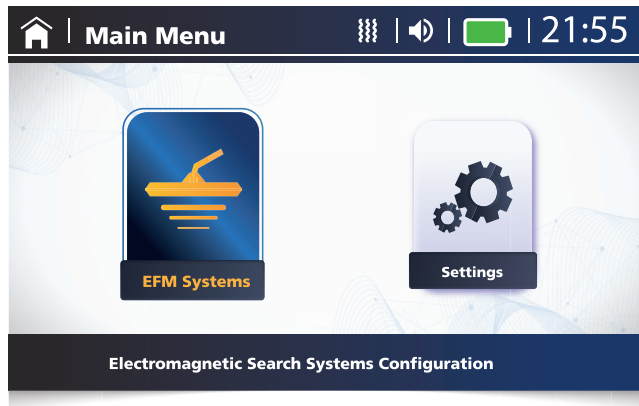

## Display:

**Brightness:** Move the pointer using the navigation arrows to edit brightness level. The brightness level can be set from 0 to 100% adding 1%. Brightness maximum level is 450 nits.

**Sleep:** Adjust auto dimming for brightness level for power saving. This mode can be set on 15,30,45,60 or 75 seconds.

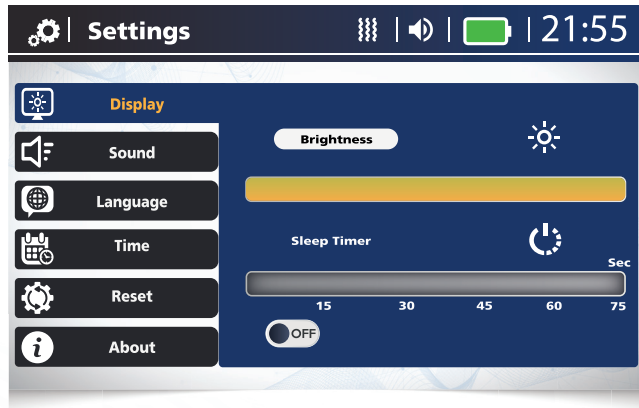

## Sound:

**Sound:** you may adjust sound level from 0 to 100 using the navigation arrows.

**Vibration:** You may switch ON/OFF

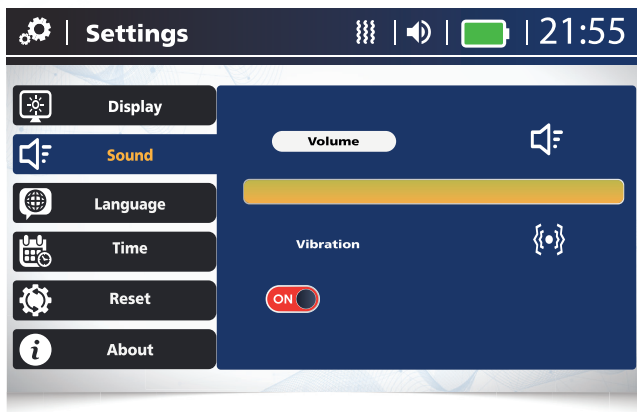

## Language:

The device supports six different languages: English, French, Spanish, Deutsche, Russian, and Arabic, choose the language and press OK.



## Time:

You can set the time and date using the navigation arrows increasing or decreasing.

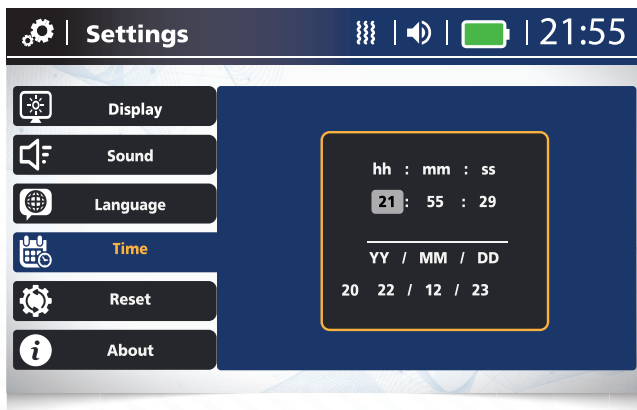

## Reset:

Choose the reset choice, by confirming the message on the screen.



## About:

Also includes device information:

- Device Name
- Display Version
- Version
- Battery
- Software Version
- UpTime

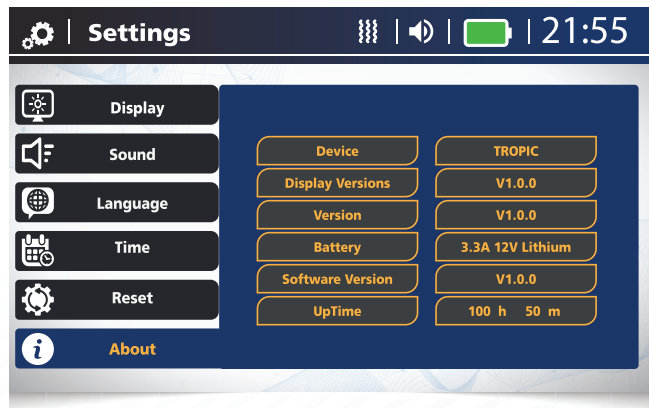



## Tropic device specifications

- Tropic supports one main system to detect metals and precious targets, the all new EFM system which is used to detect coins and treasures.
- EFM system is used to locate small and deep targets accurately, through the attached search coil which is high qualified.
- Discrimination between precious and non-precious metals and describe the type and ignorance of iron.
- EFM system basically depends on sending electromagnetic waves through the search coil to pass earth layers without being affected, the search coil will receive back these waves, the received wave makes a copy of the sent wave in case target does not exist, or in case detecting a target the received wave will carry some changes according to the target type.
- The received waves are editable by digital filters and analog highly developed and precise to get pure electrical signal and will be analyzed and programmed in mathematical equations to figure out the target type and its depth to the ground.
- It works with all terrains and soil types as it sends suitable signals that passes the ground layers ignoring the soil type,
- Light weight – Easy to assemble and disassemble.

- Make sure to keep (Mobile phone, hand watch, bracelets, necklace, jewels, belt or any other metallic object) away of at least 200 meters from the scan area so the received signals do not get affected which leads to incorrect results.
- Be away from industrial regions or ionic trash and high voltage electric lines, if needed you should decrease the device sensitivity in the search system.
- In case two or more devices are used in the same area, the distance between both should be no less than 100 meters.
- The device should not be subjected to microwaves directly, it leads to device damage and may cause fire.
- Do not unplug the cable, that leads to device damage.

EFM basically depends on sending electromagnetic waves through the special search coil to pass the earth layers whatever type was it, the coil will receive back the waves, When there is any target, the received wave will carry some changes in phase and amplitude from those that were transmitted previously, these changes differ according to target type, this wave will be edited and filtered through advanced and accuratedigital and analog filters to obtain a pure electrical signal, then these signals are translated programmatically and by performing mathematical operations that candistinguish the type and depth of the target.

The used coil in the EFM system is ideal to detect small gold nuggets and so the big targets .

## Device set up for EFM system.

- Untighten the Bolts **6** and nuts **4** special for the Clamp of the main unit **5** .
- Insert the handle of the main unit into the clamp and tighten the bolts and nuts.
- Unlock the carrying pole .
- Extend the pole to the desired length.
- Lock the pole lock.
- Align the search coil **3** with the extension pole's head **8** and put the coil bolt **9** in its place and tighten the nut from the opposite side.
- Wrap the cable around the stick.
- Insert connection unit **2** in the front of the main unit within the specific socket, [Figure \(1\) \(2\)](#)

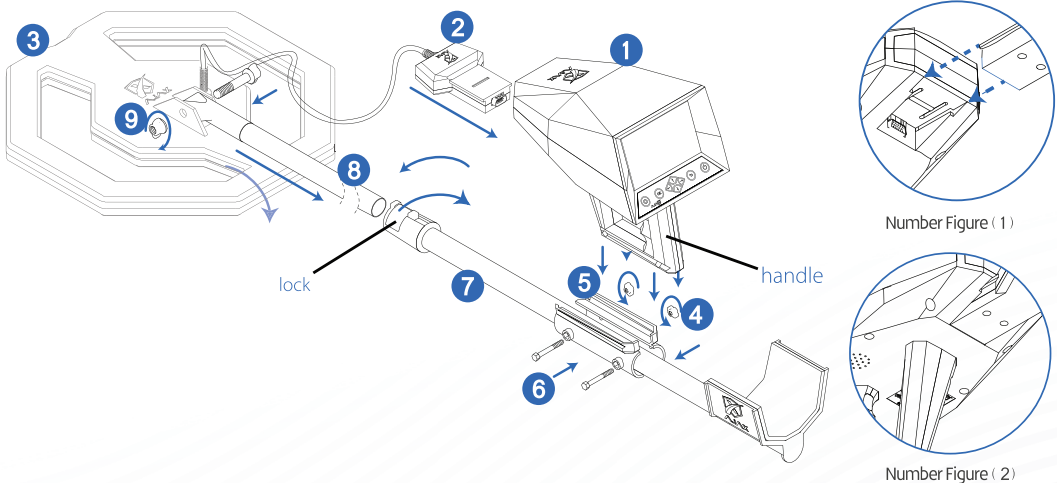

Select EFM system from the main menu.

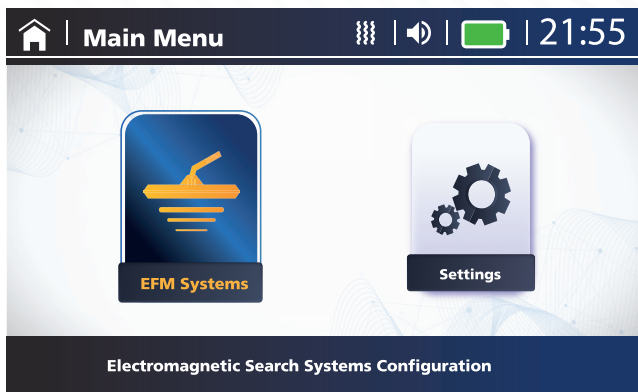

The device will show an interface of the supported scan systems

- Discrimination
- Graph
- Quick Scan
- EFM Settings

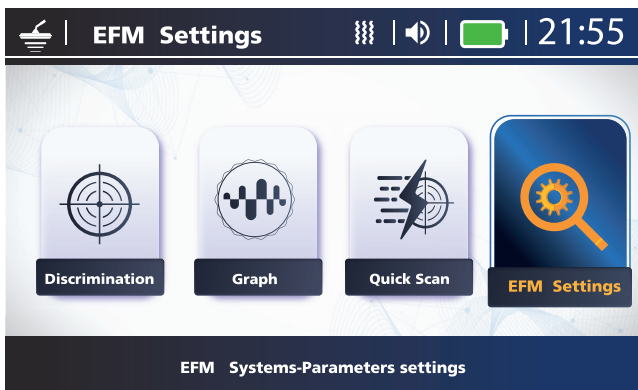

Select EFM settings and press OK, the calibration interface will show up, sensitivity, iron discard, tone.

## 1- Calibration

And it's two types\manual and automatic

Follow the instructions before starting using page 22 before doing the calibration.

Automatic calibration: make the coil on a 35 cm height, the press the grip key till hearing a sound from the device, and another sound one more time different from the first one, after that low down the coil height to 10 cm from the ground level and wait (Watch the coil movement on the screen) until a message shows up / Automatic calibration is completed successfully.

Manual Calibration: The most accurate and recommended.

After choosing EFM settings the calibration interface shows up, raise up the coil 10 cm from the ground level and watch the moving balance indicator at the bottom of the screen, when the indicator points to the right raise up the coil to 35 cm then press the right arrow key many times (10 or 15 times if the indicator was near from the right side, and less if the indicator was after the center a little) then low down the coil to 10 cm and you will notice that the indicator place has changed and became near to the center, raise up one more time to 35 cm and press the right arrow key less times than the previous one, low down the coil to 10 cm one more time you will notice that the indicator became very close to the center, repeat the process by pressing the right arrow key once or twice then low down the coil to 10 cm you will notice that the indicator became stable in the center and the manual calibration is completed.

**Note:** press the left key if the indicator was moving toward the left at the beginning of the manual calibration as explained previously when the indicator is on the right.

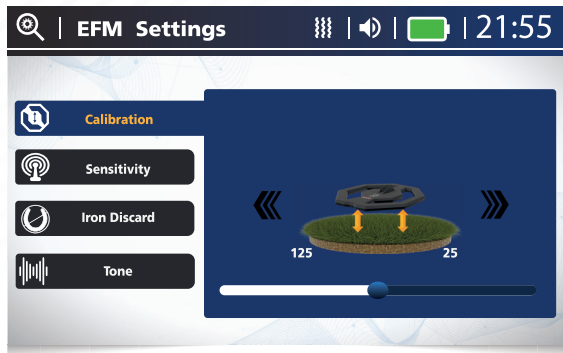

## 2- Sensitivity

Sensitivity can be controlled based on soil type, Whenever the soil has little magnetic homogeneity (soil with mineral impurities), the sensitivity must be reduced until the device stops receiving the fake signals resulting from the impurities, And when the magnetic homogeneity of the soil is available, the sounds of the device decrease due to the lack of imaginary signals that were emitted by impurities, then the sensitivity can be increased so that the user can reach targets with greater depths. The sensitivity is controlled by pressing the left and right control arrows.

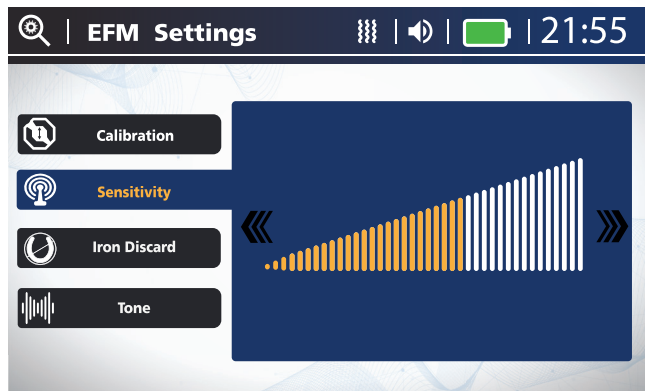

## 3- Iron discard

When this option is activated, the device ignores the ferrous elements in the soil, and it can be activated or canceled by pressing the right or left key.

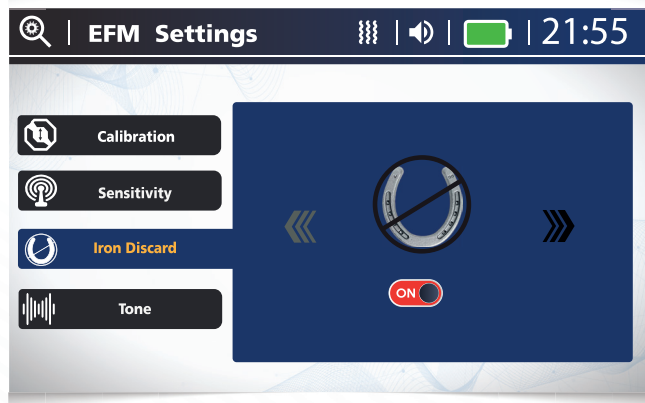

## 4 - Tone

You can customize a sound for ferrous targets and a different sound for non-ferrous targets when choosing (ON) and then the number 2 appears, which expresses the number of assigned tones, and if (OFF) is selected, one tone is chosen for all targets and the number 1 appears as in the interface.

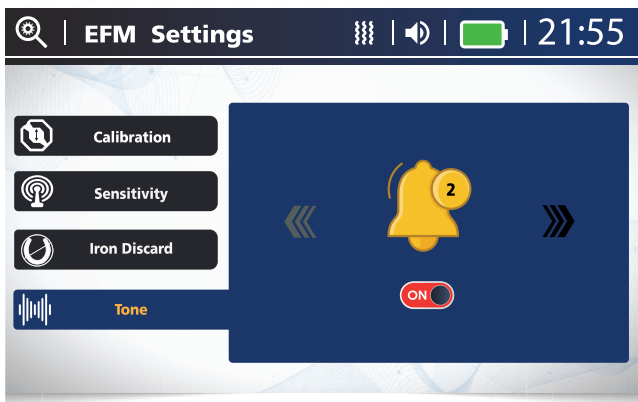

Note: The options that you set previously remain saved even after restarting the device, and they are on the left side of the interface of each system.

After adjusting the EFM settings, go to the systems interface by pressing the OK key or by pressing the back key, then you can choose one of the EFM systems

It is preferable, when starting any scan operation in a new area, to start with the quick scan system.



## 1- Quick scan

This system enables the user to do scan process more quick than other systems, so the device gives sound alerts when reaching a target.

It shows on the right side of the scan interface the type of target, and in the center shows the discrimination number which points to target type / when the discrimination number is in red color that means the metal is nonprecious and when it's in yellow then it means precious metal.

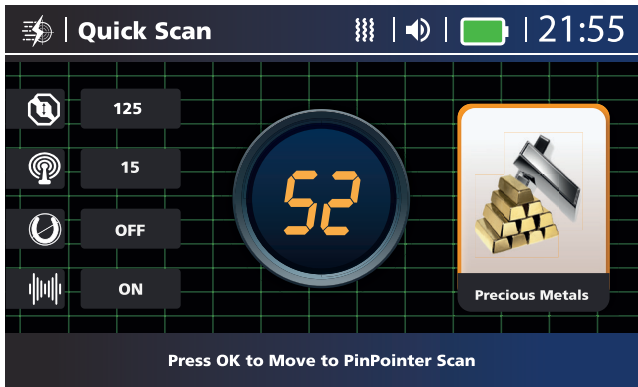

Look at the table below:

(Table of numerical values for types of goals)

Discovered Target	Target Digital Value
Iron and non-precious metals	10—35
Mix (Iron & Gold)	35—40
Gold	40—70
Precious Mix (Gold and precious metal/s)	70—75
Other precious metals: Chrome, Aluminum, Copper, Nickel, Zinc	75—90

## Scan method (Quick scan)

- Select the quick scan from the main menu where you will see the special interface of this system.

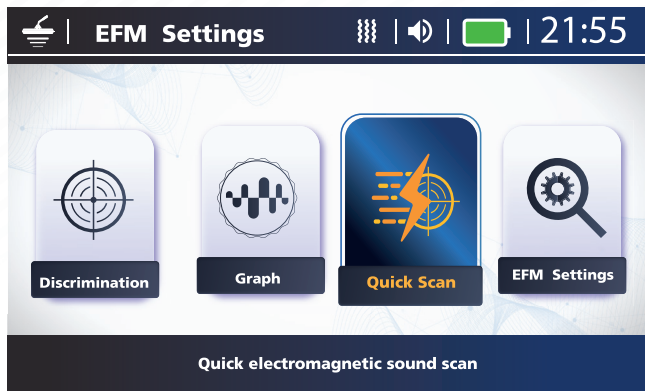

- Hold the device where the height of the search coil is 5-10 cm above ground level, move straight in a medium speed and constant and move the coil right and left with keeping the coil parallel with the ground level, Figure (3) (4) (5)

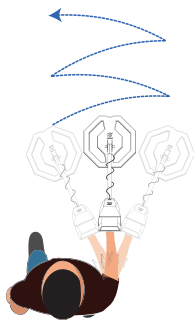

Number Figure ( 3 )

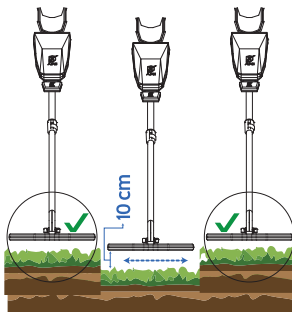

Number Figure ( 4 )

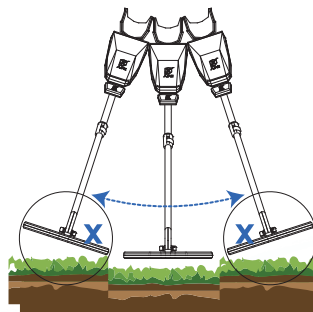

Number Figure ( 5 )

- Watch the results according to digital value table for target types.

- When pressing the grip key, a fast ground balance will happen and the process of the target evaluation will repeat again when detecting a target, Press **OK** to start the PinPointer accurate scan.

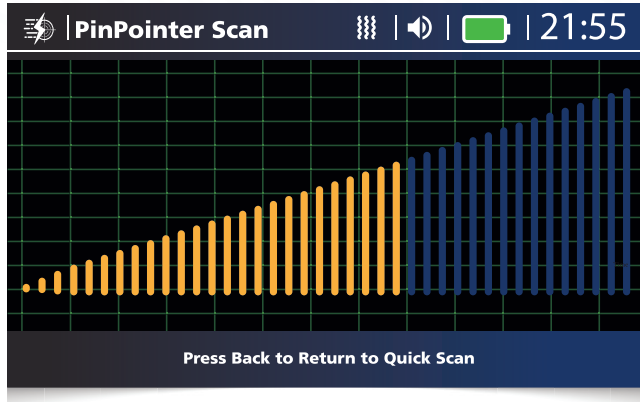

An indicator will show up to determine the target accurately avoiding random drilling, keep the height from 5-10 cm and watch the signal increasing, the sound volume and vibration when closing the coil center from the target and here you can locate the target place accurately without any target discrimination.

**Note:** You can press the back button to return to target discrimination through the quick scan.

## 2- Discrimination

It's recommended to use this system when a target is detected, and you want to know its type.

This system can discriminate between targets vocally and through the digital value to the target type as mentioned in the previous table of the quick scan. In this interface, a circular indicator like a speedometer appears, with two indicators indicating the type, size, and distance of the target.

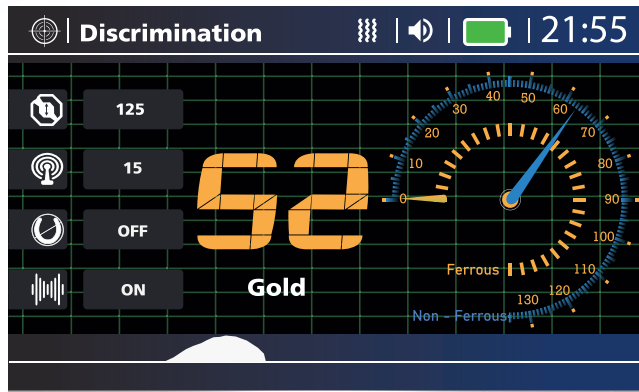

- The big red indicator points to precious metals.
- The small yellow indicator points to non-precious metals.
- In the bottom of the interface a 2D chart appears in white indicates to precious target existence when it's positive (above the line) and non-precious when it appears in the negative place (under the line), when pressing the grip key, a fast ground balance happens and the process of target evaluation repeats again and the chart starts from the beginning again.
- In the middle we see a big number which is the discrimination number that points to the detected target identity (according to the previous digital value table) and the yellow color appears when the metal is precious, and the red color appears when the metal is non-precious and the target name will show up under this number.

## Scan method (Discrimination)

Select Discrimination system from the main menu, the program interface will appear.

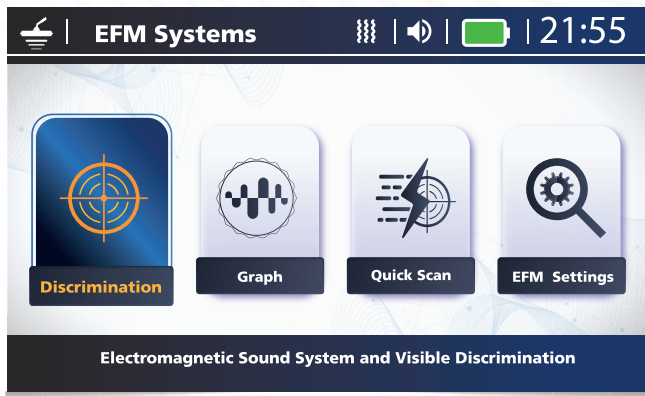

Hold the device with raising the coil 5-10 cm from the ground level.

Move slowly in continuous steps and medium speed to the front or to the back with keeping the device direction and keeping the height of the coil and to be parallel with ground level without any movement right or left, when detecting a target the device gives continuous sound alerts with vibration, if the vibration mode is active,

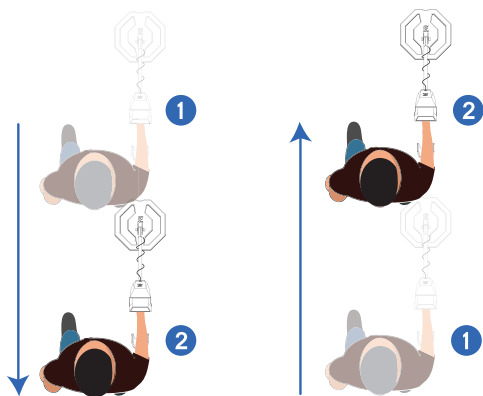

and the signal, the sound volume and vibration increase when closing to target and numbers will appear on the screen points to target type while yellow points to precious metals and red points to non-precious metals in addition the target name will be shown under the discrimination number.

### 3- Graph

This system is used to find out the beginning and the end of the target and find its density, depth, and size through a 2D Graph as follows; Precious metal: the signal shape is positive (in the upper part) and in green color and the greater height means that target is bigger, closer, or higher density.

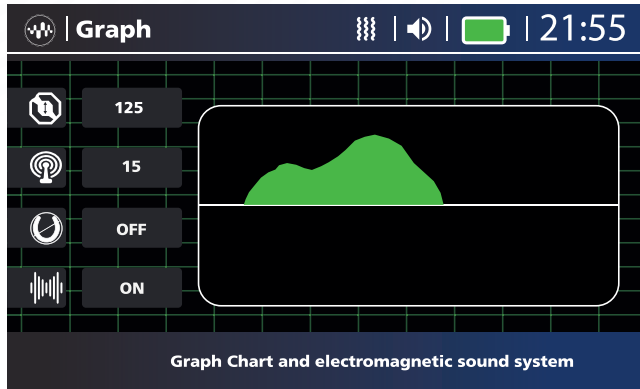

Ferrous (non-precious): the signal shape is negative (in the lower part) in red color and the greater height means the target is bigger, closer or higher density.

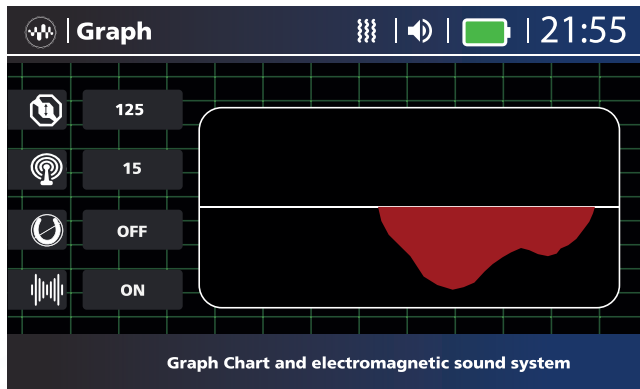

## Scan method (Graph)

Select the search system from the main menu, the special interface of this system will appear

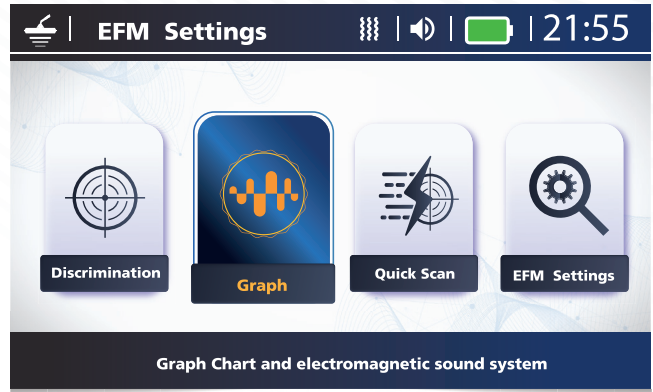

Hold the device with raising the coil 5-10 cm from the ground level, start walking continuously in a medium speed to the front or back with keeping on the device direction without return and keeping the coil height and to be parallel to the ground level without any movement right or left.

When detecting a target, the device gives continuous sound alerts with vibration if vibration mode is activated.

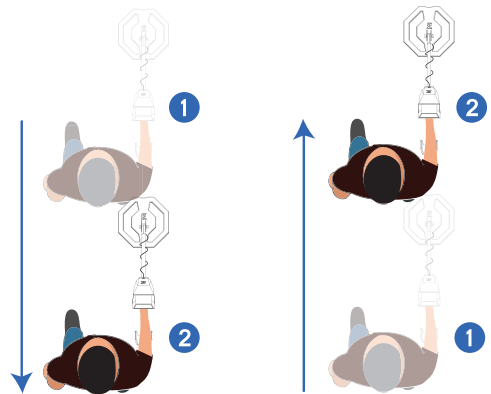

If the target is precious the signal will be positive above the line in the green color, and it will be negative and under the line in red color if the target was ferrous and non-precious as explained above.

The signal power increases with the sound and vibration when closing to target.

**Note:** when pressing the grip key, a quick ground balance happens and the target evaluation process repeats and the Graph repeats.





## WEEE (Waste electrical and electronic equipment) statement

To protect the global environment and as an environmentalist AJAX must remind you that Under the European Union ("EU") Directive on Waste Electrical and Electronic Equipment, **Directive 96/2002/EC, which takes effect on August 2005**, products of »electrical and electronic equipment« cannot be discarded as municipal waste anymore, and manufacturers of covered electronic equipment will be obligated to take back such product at the end of their useful life. AJAX will comply with the product take back requirements at the end of life of AJAX branded products that are sold into the EU. You can return these products to local collection points.



## Environmental Policy

The product has been designed to enable proper reuse of parts and recycling and should not be thrown away at its end of life. Users should contact the local authorized point of collection for recycling and disposing of their end-of-life products.

## Visit the AJAX website

and locate a nearby distributor for further recycling information.

Users may also reach us at [info@ajaxdetector.com](mailto:info@ajaxdetector.com) for information regarding proper Disposal, Take-back Recycling, and Disassembly of AJAX products.



## WEEE (Waste electrical and electronic equipment) statement

### European union:



Batteries, battery packs, and accumulators should not be disposed of as unsorted household waste. Please use the public collection system to return, recycle, or treat them in compliance with the local regulations.

### Taiwan: 廢電池請回收



For better environmental protection, waste batteries should be collected separately for recycling or special disposal.

### California, USA:



The button cell and Li-ion battery may contain perchlorate material and requires special handling when recycled or disposed of in California.

For further information please visit:

<http://www.dtsc.ca.gov/hazardouswaste/perchlorate/>



## Contact information

 1201 N.W. Briarcliff Parkway, 2nd Floor  
Kansas City, Missouri, 64116, USA

 +1 816 298 0485

 +1 816 399 3744

 [info@ajaxdetector.com](mailto:info@ajaxdetector.com)

 [www.ajaxdetector.com](http://www.ajaxdetector.com)



**AJAX**  

---

**DETECTION TECHNOLOGY**

---

